



Web server

OZW772... V4.0

For Synco™, Synco™ living

Web server OZW772... allows for remote plant control and monitoring via the web and Smartphone-App. Four versions of the web server are available: To connect 1, 4, 16, or 250 KNX devices from Synco 700, RXB/RXL room controllers, RDG/RDF/RDU room thermostats, and the QAX9... Synco living central apartment units.

- Operate via web browser with PC/laptop and Smartphone.
- Operate via Smartphone app (iPhone and Android).
- Visualize the plants in the web browser based on standard plant diagrams and customized plant web pages.
- Connections: USB and Ethernet.
- Display fault messages in the web browser.
- Send fault messages to a maximum of 4 e-mail recipients.
- Periodically send system reports to e-mail recipients.
- Acquire and display consumption data.
- Send consumption data file to 2 email recipients.
- Function "Energy indicator" to monitor data points for energy-related limit values, or "Green limits".
- Web services for external applications via Web API (Web Application Programming Interface).
- Encrypted with https and TLS for emails.

Use

Building

- Apartments in single and multi-family homes.
- Office and administrative buildings, residential housing.
- Schools, gymnasiums, leisure facilities, hotels.
- Municipal buildings, smaller industrial buildings.

Owners/operators

- End customers, HVAC and electrical installers.
- Real estate companies, real estate management companies.
- Building maintenance companies, facility management.

Functions

Commissioning

Commissioning is carried out via PC/Laptop and Web browser or ACS.

Web operation

- Remotely operate and monitor plants and devices on a KNX network using a web browser on PC/laptop and Smartphone.
- Simultaneously support multiple users.
- User accounts for web operation (user groups, operating language).
- Set up visualized operation based on standard plant diagrams (loaded via HVAC Integrated Tool, HIT) or customized plant web pages.

User interface

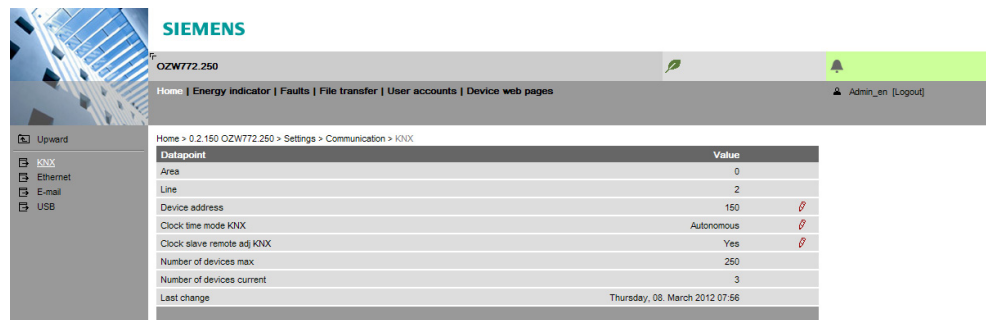

Primary navigation

Primary navigation offers the following functions:

Home	Menu-based plant and device operation.
Energy indicator	Display and operate "Energy indicator" data points.
Faults	Display system faults.
File transfer	Download consumption data and event history, upload documents, logos and system definitions.
User accounts	User administration.
Device web pages	Create device list and operating pages.

Secondary navigation

The secondary navigation (menu tree) allows users to select devices and operating pages.

Display

The display range displays content corresponding to the selected primary and secondary navigation.

Plant state



The display indicates no fault or the most serious plant fault depending on plant state.

Faults

Fault sources

The web server recognizes failures and fault signals from KNX devices contained in the device list. Own faults also are recognized.

Fault display, fault acknowledgement

The LED  signals a fault on the web server. The LED  blinks to indicate that a fault is unacknowledged. The LED continues to be lit for as long as the fault is pending after the fault is acknowledged with the  button via web operation or ACS. (See page 10 for LED displays and operating buttons).

Fault status message

Fault status messages can be sent as an e-mail to as many as 4 e-mail recipients and/or via a service provider to SMS recipients. The fault priority for each e-mail recipient (urgent/all) can be set. Each recipient has a "Time switch with calendar" to program three sending times per day and holidays/special days.

System report

System messages

The web server generates system reports and periodically sends the system state to e-mail recipients. Messages are sent as per the set time (hh:mm), the message cycle interval (1...255 days), and priority (urgent/non-urgent).

Connection test

Press the  button on the web server to send a system report to all defined email recipients regardless of fault priority.

History

The last 500 fault events, fault messages and system reports are entered in the web server's circular message buffer. The events or history data can be read via web browser.

Time of day

The web server has a system clock with adjustable time zone and daylight saving/standard time changeover. As clock time master, it can send the set system time (date and time) to KNX devices (clock time slave).

Updates

We differentiate between the following:

- System definition updates to integrate device descriptions of new devices in the web server.
- Firmware updates to update the web server to the latest firmware version. Firmware updates may also contain new device descriptions (system definitions).

A system definition update requires one simple action via the web browser. No operator actions on the web server are required to update the firmware. Procedures are communicated when a firmware update is issued.

Compatible with ACS790

The web server is compatible with the Service and Operating software ACS790 V8.00 and higher.

Visualize plants

Web server OZW772... allows for visualizing technical equipment in buildings via plant web pages. For example, a plant web page can be set up visualizing a plant with data points (max. 100 data points per plant web page) on a floor plan.

In the event of a fault, users can quickly access the impacted locations.

For writable parameters, users can click to open a dialog box and change the parameter.

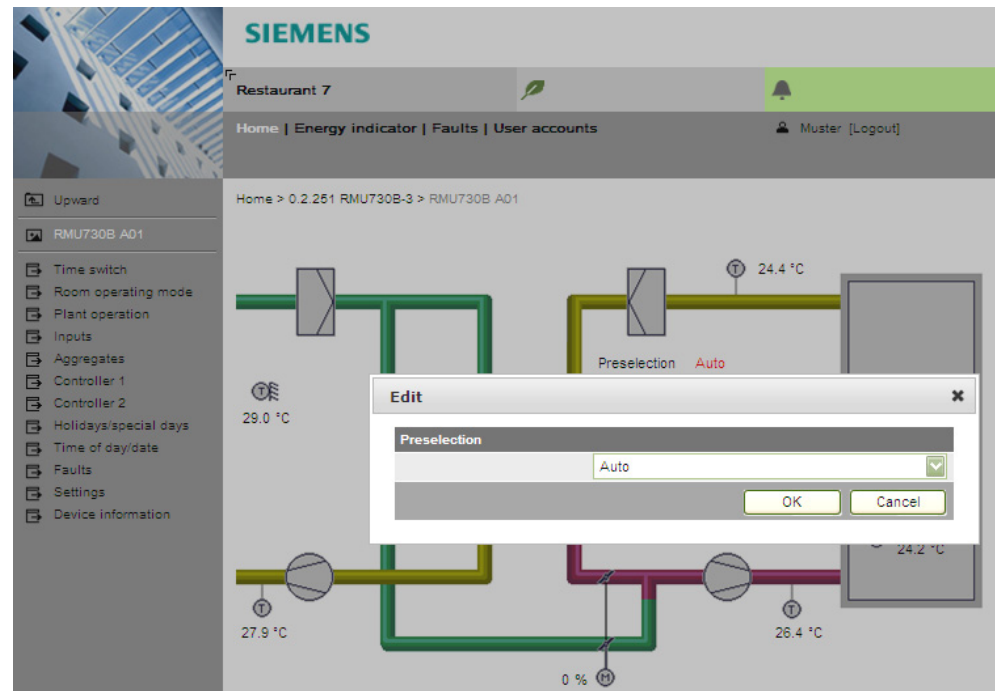

Download plant diagrams

Web-capable plant diagrams can be downloaded from the HIT online platform for Synco 700 devices, RXB/RXL room controllers, and room thermostats RDG/RDF/RDU.

Create own plant web pages

You can freely design plant web pages. As a hybrid form, you can also modify and extend downloaded plant diagrams.

Web page elements

Users can also embed additional data in a plant diagram such as links to plant, function and maintenance descriptions or data sheets. Moreover, users can integrate external links allowing, for example, to directly browse multiple plants. Users can embed current webcam images in a plant diagram.

Consumption data acquisition

Function "Consumption data acquisition" is available on the OZW772... web server from V3.0. The following devices are supported:

- Synco 700: RMU7x0B, RMH760B, RMK770 (from V2.0), RMS705, RMS705B, RMB795, RMB795B
- Synco living: Central apartment units QAX903, QAX913

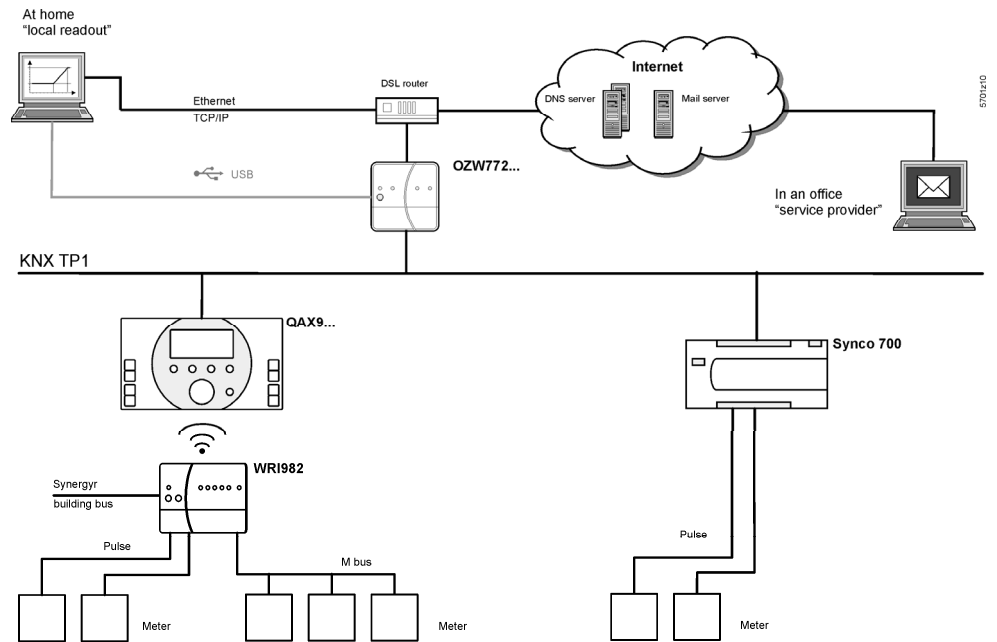

Meter

Current consumption data is saved in the meters (legal requirement).

QAX / Synco 700

- Every 4 hours, QAX9... central apartment unit receives raw data via KNX radio.
- Synco 700 controllers generate the meter data via pulse inputs as per the configured valency.

Consumption data can be viewed on individual QAX central units or Synco controllers using the associated menus.

Web server, local or remote

The web server offers comfortable access to consumption data:

- The web browser on the web server allows users to navigate to the consumption data of the associated devices.
- Or a consumption data file can be downloaded from the web server. The file contains a list of consumption data for all QAX units (apartment units) and Synco controllers.
- Users can access the web server either local or remote via the Internet.

Web server, email

Consumption data can be sent periodically (set up via web server) to max 2 email recipients (e.g. billing company).

**Function
"Energy indicator"**

Function "Energy indicator" is available on the OZW772... web server from V4.0. The following devices are supported:

- Synco 700: RMU7x0B, RMH760B, RMK770 (from V2.0), RMS705B, RMB795B
- Synco living: Central apartment units QAX903, QAX913, QAX910 (from V3.0)
- Room controllers: RXB2x, RXL2x, RXB3x, RXL3x
- Room thermostats: RDF301, RDU341, RDGx00KN

The web server uses the "Energy indicator" function to read selected data point values from the bus devices and to compare the values to energy-related limit values, or so-called "Green limits".

The data points are also monitored for adherence to the "Green limits". As a result, the "Energy indicator" is displayed in the form of a tree leaf.

Note

The "Green limits" are used only together with the "Energy indicator" function. They do **not** represent process or safety limit values which trigger e.g. fault messages or turn off the plant in the event of limit violations.

**Tree leaf as
"Energy indicator"**

Green leaf 

"Green leaf" → Green tree leaf, leaf pointing up.

- The "Green leaf" symbol indicates that a data point value has not exceeded its "Green limit", i.e. the value is within a "green" range in terms of energy consumption.

Orange leaf 

"Orange leaf" → Orange tree leaf, leaf pointing down.

- The "Orange leaf" symbol indicates that a data point value has exceeded its "Green limit", i.e. the value is outside a "green" range in terms of energy consumption.

Standard EN 15232

The "Energy indicator" function is based on standard EN 15232 "Energy efficiency in buildings".

**Example: Web page
"Energy indicator"**

Web page with "Energy indicator" function; example with data points from "Room 1" and open dialog box to set data point value "Comfort heating setpoint" and its "Green limit" (for "Room 1").

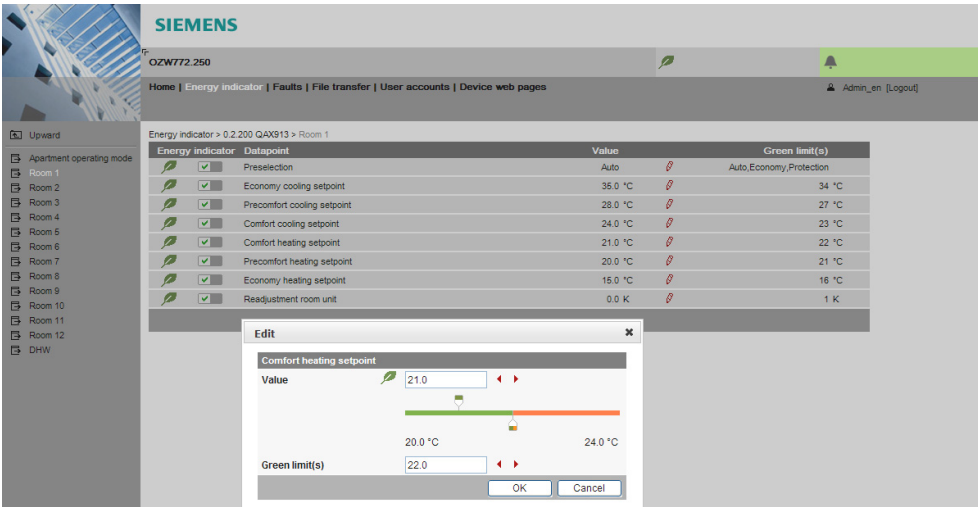

Energy indicator	Datapoint	Value	Green limit(s)
	Preselection	Auto	Auto, Economy, Protection
	Economy cooling setpoint	35.0 °C	34 °C
	Precomfort cooling setpoint	28.0 °C	27 °C
	Comfort cooling setpoint	24.0 °C	23 °C
	Comfort heating setpoint	21.0 °C	22 °C
	Precomfort heating setpoint	20.0 °C	21 °C
	Economy heating setpoint	15.0 °C	18 °C
	Readjustment room unit	0.0 K	1 K

Web services

The "Web Application Programming Interface" (Web API) is an interface to make web services on a web server accessible to clients.

All Web API functions are called up via "http" or encrypted "https". Each session begins with authentication on the web server.

Example for app operation

If the "Home Control App" is installed on a smartphone, the web services can access the data points of the devices on the KNX network via the Web API (communication connection for smartphone see page 9).

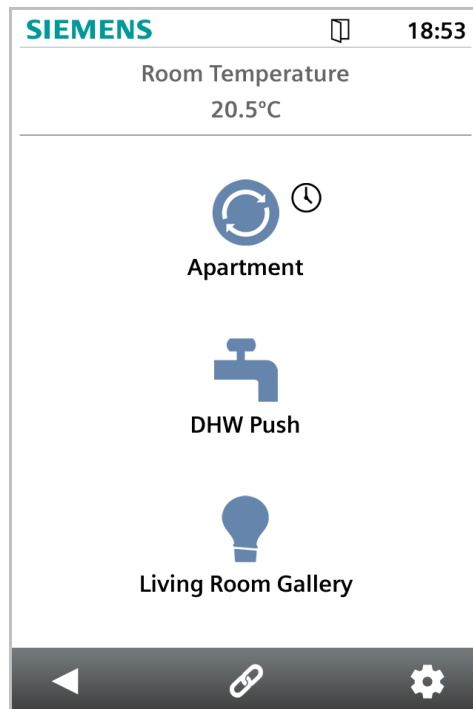

Type summary

Name		Product number
Web server	for 1 KNX device	OZW772.01
Web server	for 4 KNX devices	OZW772.04
Web server	for 16 KNX devices	OZW772.16
Web server	for 250 KNX devices	OZW772.250

Ordering and delivery

When ordering, please specify the name and **product number**. Example:

- Web server **OZW772.16**

The web server is delivered in a cardboard box.

The following is included in the package:

- Installation instructions G5701xx (multilingual).
- Power cable, power supply AC 230 V.
- Ethernet cable.
- USB cable.
- 2 cable ties.

Equipment combinations

The following KNX devices from the Synco product range can be connected to each OZW772 web server.

Synco product range

Synco 700

KNX devices		Data sheet no.
Universal controllers	RMU7x0, RMU7x0B	N3144, N3150
Heating controllers.	RMH760, RMH760B	N3131, N3133
Boiler sequence controller	RMK770, RMK770 V2	N3132
Central control unit	RMB795, RMB795B	N3121, N3122
Switching & monitoring unit	RMS705, RMS705B	N3123, N3124
Bus operator unit	RMZ792	N3113
Room unit	QAW740	N1633
Central communication units	OZW771, OZW775	N3117, N5663

Synco RXB/RXL

Room controllers	RXB21.1, RXB22.1	N3873
Room controllers	RXL21.1, RXL22.1	N3877
Room controllers	RXB24.1	N3874
Room controllers	RXL24.1	N3878
Room controllers	RXB39.1/FC-13	N3875
Room controllers	RXL39.1/FC-13	N3876

Synco RDG/RDF/RDU

Room thermostat for fan coils	RDF301	N3171
Room thermostat for fan coils and lighting	RDF301.50	N3171
Room thermostat for VAV	RDU341	N3172
Room thermostat for fan coils	RDG100KN	N3191
Room thermostat for VAV	RDG400KN	N3192

Synco living

Central apartment unit	QAX903	N2741
Central apartment unit	QAX910	N2707
Central apartment unit	QAX913	N2740

Product documentation

	Document type	Document no.
Web server OZW772...	Data sheet (this document)	N5701
	Installation instructions (package insert)	G5701
	Commissioning instructions	C5701
	CE declaration of conformity	T5701
	Environmental product declaration	E5701
KNX bus	Data sheet	N3127
	Basic documentation	P3127
ACS790 software	Data sheet	N5649
Service tool OCI700.1	Data sheet	N5655

Technical design

Web browser	Devices	Requirements
	PC/Laptop (1024 x 786)	Internet Explorer V7.0 or higher recommended Firefox V3.0 or higher.
	iPhone (480 x 320)	Safari (specific to end device)

Number of browsers Any number of browsers can be used simultaneously. The maximum data throughput rate is distributed among the browsers. Operation slows down as the number of users increases accordingly.

Operation, monitoring, alarming Communication connections for local commissioning (USB) and remote operation, remote monitoring and alarming via Ethernet.

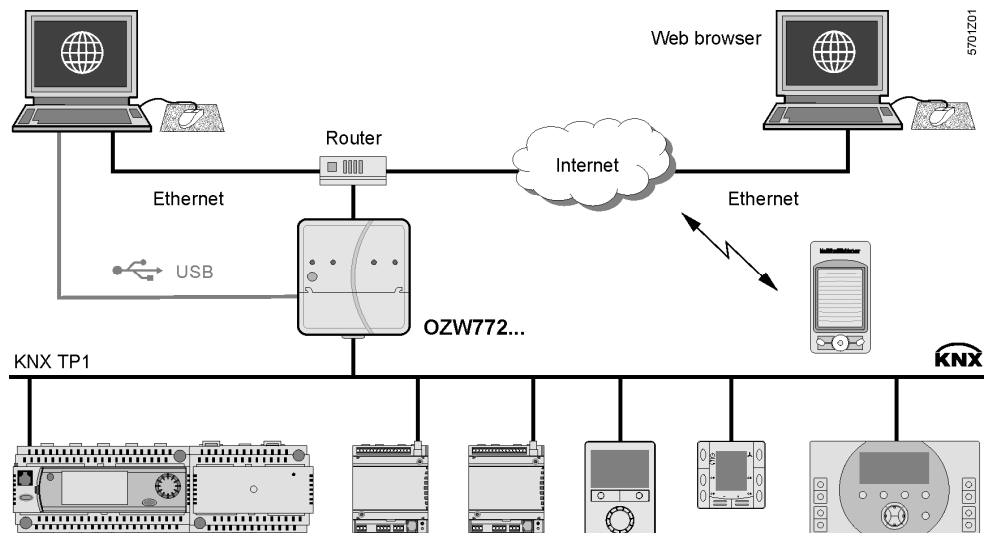

Interfaces

USB

The USB interface directly connects the PC/laptop on site. The required USB cable type A – type Mini-B is delivered with the device.

- Ethernet** The router/network is connected to the Ethernet RJ45 plug. The Ethernet interface features Auto-MDI(X) for crossed and non-crossed Ethernet cables. An Ethernet category 5 cable is supplied.
- KNX** The KNX bus is connected to the CE+ and CE- connection terminals labeled "KNX". See data sheet N3127 for more information on the KNX bus.
- Logs**
- Web operation** Use HTTP (Port 80) via TCP/IP for web operation. In addition https encryption via port 443 is supported. The required certificate is not accredited. The self-signed certificate from Siemens is valid for 20 years and is installed on the web server. The certificate can be installed on the web browser as needed.
- A RNDIS driver on the PC/laptop is required for USB communication. The RNDIS driver is automatically installed on PC/laptops connected to the Internet (provided the network administrator enables "online update"). The RNDIS driver is also saved to the web server under <http://<IP address>/drivers/>.
- Send email** Fault messages and consumption data are sent in an email via SMTP. The email is encrypted using TLS if supported by the mail server.
- DHCP client** The web server can take over its network configuration as a client of a DHCP server.

Design

Basic design

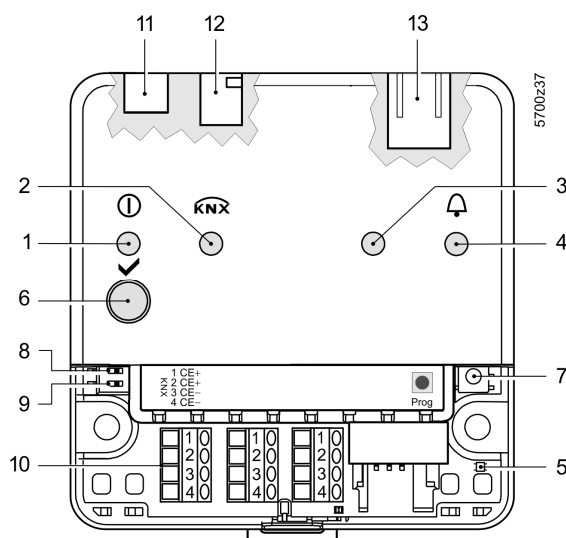

The web server consists of a housing lower section containing printed circuit boards with interfaces. The upper housing section covers the printed circuit boards. The upper housing section contains the LED displays and one operating button. The connection terminals and additional display and operating elements are located under the removable cover for the upper housing section. All display and operating elements are labeled.

Display and operating elements









Pos	Name
1	LED ① Operation and "Energy indicator"
2	LED KNX
3	LED field bus 2 (reserve)
4	LED fault ⚠
5	LED addressing mode
6	Remote button ✓
7	Addressing mode button Prog
8	"Message suppression" switch
9	Switch 2 (no function)
10	KNX bus connection terminals
11	Operating voltage connection
12	USB connection Mini-B
13	Ethernet connection, RJ45 plug





LED displays

1  (red/green/orange)	<ul style="list-style-type: none">• Dark• Steady red• Flashing red• Steady green• Steady orange	No operating voltage DC 24 V. Web server starts operating system. Web server starts application. Web server operational, "Energy indicator" = "Green leaf". Web server operational, "Energy indicator" = "Orange leaf".
2  (green)	<ul style="list-style-type: none">• Dark• Lit• Flashing	No bus power. KNX operational. Communication on KNX.
3 Field bus 2 (reserve)	<ul style="list-style-type: none">• Dark	No function.
4 Fault  (red)	<ul style="list-style-type: none">• Dark• Lit• Flashing	No fault (normal operating state). Acknowledged fault. Unacknowledged fault.
5 Addressing mode (red)	<ul style="list-style-type: none">• Dark• Lit	KNX addressing mode off. KNX addressing mode on.

Operating buttons

6 Remote button 	<ul style="list-style-type: none">• Short (< 2 s)• Long (> 6 s)	Acknowledges fault message. Sends system report to the fault e-mail recipients (not to consumption data and "Energy indicator" recipients)
7 Addressing mode 	<ul style="list-style-type: none">• Short (< 2 s)	Press once: KNX addressing mode on. Press again: KNX addressing mode off.
Button combinations		
 and 	<ul style="list-style-type: none">• Long (> 6 s)	Simultaneously pressing the buttons  and  restores defaults.  All configuration data and settings are reset. The device list, plant diagrams, and unsent messages are deleted. History data is not deleted.

Switches

8  Message suppression	<ul style="list-style-type: none">• Position ON • Position OFF 	Sending messages is suppressed. Sending messages permitted.
9  DIP switch 2	<ul style="list-style-type: none">• Switch settings	No function.

Notes

Installation

The web server can be mounted in a panel, distribution box, or on a wall. Include space for wiring when planning. Make sure service can easily access the unit and the unit is ventilated properly.

- Standard mounting On standard rail TH 35-7.5.
- Wall mounting Attached with 2 screws.
- Mounting position Horizontal or vertical.
- Mounting and dimensions See "Dimensions".

Install

Important notes

Observe the following when installing:

- Run fuses, switches and wiring as per local regulations for electrical installations.
- We do not recommend plant monitoring via USB interface in environments with strong electromagnetic interference (e.g. in industrial environments with electrical welding equipment).
- See "Technical data" for electromagnetic compatibility.

Operating voltage

The supplied AC 230 V power supply provides the DC 24 V operating voltage for the web server.

Wiring

The operating voltage, USB and Ethernet plugs are located on the upper part of the housing.
The terminals on the device for the KNX bus are located under the removable cover.

Connection terminals

The connection terminals are designed for wire diameters of min. 0.5 mm or cross-sections of 0.25...1.5 mm² or stranded wire cross-sections of 0.25...1.0 mm².

Commissioning

Connections

The web server is commissioned locally via USB with a PC/laptop. A web browser must be installed on the PC/laptop. The supplied USB cable type A – Type Mini-B connects the web server to the PC/laptop.

Additional information is available in the installation instructions G5701 inserted in the package or the commissioning instructions C5701, available at: <http://<IP address>/doc/>

Router



A suitable router is required for remote operation via Internet. The router must support NAT/PAT as well as DynDNS for dynamic IP addressing.

IP address

- The IP address via USB is set: **192.168.250.1**.
- Default setting for the IP address via Ethernet: **192.168.2.10**.
- The network administrator must provide an IP address for the web server before you can connect the web server via Ethernet to a managed network.

User groups	User accounts are created and assigned to specific user groups for customized user operation.
End user	<ul style="list-style-type: none"> • Access to end-user data and fault overview. • Operate and monitor via menu tree and plant diagrams. • Administer own user accounts.
Service	<p>Same as end user. In addition:</p> <ul style="list-style-type: none"> • Access service data. • Download consumption data and message history. • Upload customized logos and documents. • System definitions update. • Update device web pages.
Administrator	<p>Same as service. In addition:</p> <ul style="list-style-type: none"> • Edit device list. • Create device web pages. • Create, copy, change, and delete plant diagrams. • Select "Energy indicator" data points and change the default values of the data points and/or "Green limits" as needed. • Administer all user accounts.
Maintenance	The OZW772... web server is maintenance free (no battery changes, no fuses). Use only a dry towel to clean the housing.
Repair	The OZW772... web server cannot be repaired on site. If faulty, return to the Repair Center at the relevant Regional Company.
Disposal	<div style="display: flex; align-items: center;">  <div> <p><i>Dispose of the device as electronic waste in compliance with European directive 2002/96/EEC (WEEE) and not as municipal waste. Observe all relevant national regulations and dispose of the unit correctly. Observe all local and applicable laws.</i></p> </div> </div>

Technical data

Power cable for web server OZW772...	Operating voltage	AC 230 V ± 15 %
	Rated voltage "Euro plug"	AC 230 V EN 50075 and VDE 0620-1
	Frequency	50/60 Hz
	Power consumption (including web server OZW772...)	3 VA typical
	Protection class	II
	Output voltage	SELV 24 VDC
	Supply line fusing	Max. 16 A
	Cable length (distance from AC 230 V plug to web server)	Max. 1.6 m
	Web server OZW772...	Operating voltage
Power consumption		2 W typical
Function data	Clock reserve	Min. 72 hours
	Device list	
	OZW772.01	1 KNX device
	OZW772.04	Up to 4 KNX devices
	OZW772.16	Up to 16 KNX devices
	OZW772.250	Up to 250 KNX devices
KNX bus	Interface type	TP1 (twisted pair, 1 cable pair)
	2-wire bus	CE+, CE- (non exchangeable)
	Bus load number	E 15
	KNX bus power consumption	6 mA
	Permissible line length and cable types	See data sheet N3127
	Connection, screw terminals for	
	Solid/stranded wire (twisted or with ferrule)	Min. dia. 0.5 mm
	1 solid wire per terminal	0.25...1.5 mm ²
	1 stranded wire per terminal	0.25...1.0 mm ²
USB	Interface type	USB V2.0
	Device class	RNDIS
	Baud rate	Max. 12 Mbps (full speed)
	Connecting cable	
	Cable length	Max. 3 m
	Cable type for connection to PC/laptop	USB type A
	Cable type for connection to OZW772...	USB type Mini-B
Ethernet	Interface type	100BaseTX, IEEE 802.3 compatible
	Bit rate	Max. 100 Mbps
	Protocol	TCP/IP
	Identification	Auto MDI-X
	Connection, plug	RJ45 plug (screened)
	Cable type	Standard Cat-5, UTP or STP
	Cable length	Max. 100 m.
Standards	Product safety	
	Safety of information technology equipment	EN 60950-1
	Home and Building Electronic System (HBES)	EN 50491-3
	Electromagnetic compatibility	
	Immunity Industrial sector	EN 61000-6-2
	Emissions (Residential, business and commercial as well as light industrial environments)	EN 61000-6-3
	Home and Building Electronic System (HBES)	EN 50491-5-3
	 Conformity	
	EMC guidelines	2004/108/EC
	Low voltage directive	2006/95/EC
	Ecodesign directive	2005/32/EC
	 Conformity	
	Australian EMC Framework	AS/NZS 61000-6-3
Radio Interference Emission Standard		
Environmental compatibility		
The product environmental declaration CE1E5701en contains data on environmentally compatible product design and assessments (RoHS compliance, materials composition, packaging, environmental benefit, disposal)	ISO 14001 (environment) ISO 9001 (quality) SN 36350 (environmentally compatible products) 2002/95/EC (RoHS)	

Degree of protection	Protective category	IP30 as per EN 60529
	Protection class	III as per EN 60950-1
Ambient conditions	Operation	IEC 60721-3-3
	Climatic conditions	Class 3K5
	Temperature (housing and electronics)	0...50 °C
	Humidity	5...95 % r. h. (non-condensing)
	Mechanical conditions	Class 3M2
	Transport	IEC 60721-3-2
Materials and colors	Climatic conditions	Class 2K3
	Temperature	-25...+70 °C
	Humidity	<95 % r. h.
	Mechanical conditions	Class 2M2
Materials and colors	Upper housing section	PC + ASA, RAL 7035 (light-gray).
	Lower housing section	PC + ASA, RAL 5014 (dove blue).
Dimensions	Length x width x height (max. dimensions)	87.5 mm x 90 mm x 40 mm.
Weight	Web server OZW772...	0.136 kg
	Web server with packaging, installation instructions, power unit, USB and Ethernet cable, cable ties.	0.589 kg
	Packaging	Cardboard box
Terms, abbreviations	Auto Medium Dependent Interface – Crossed	Auto-MDI(X)
	Dynamic Domain Name System	DynDNS
	Dynamic Host Configuration Protocol	DHCP
	Energy Cost Allocation	ECA
	HVAC Integrated Tool von Siemens	HIT
	Hyper Text Transfer Protocol	HTTP
	Hyper Text Transfer Protocol Secure	HTTPS
	Internet Protocol	IP
	Konnex	KNX
	Network Address Translation	NAT
	Port and Address Translation	PAT
	Remote Network Driver Interface Specification	RNDIS
	Shielded Twisted Pair	STP
	Simple Mail Transfer Protocol	SMTP
	Transport Layer Security	TLS
	Transmission Control Protocol	TCP
	Universal Serial Bus	USB
	Unshielded Twisted Pair	UTP
	Web Application Programming Interface	Web API

Connection diagrams

Connection diagram

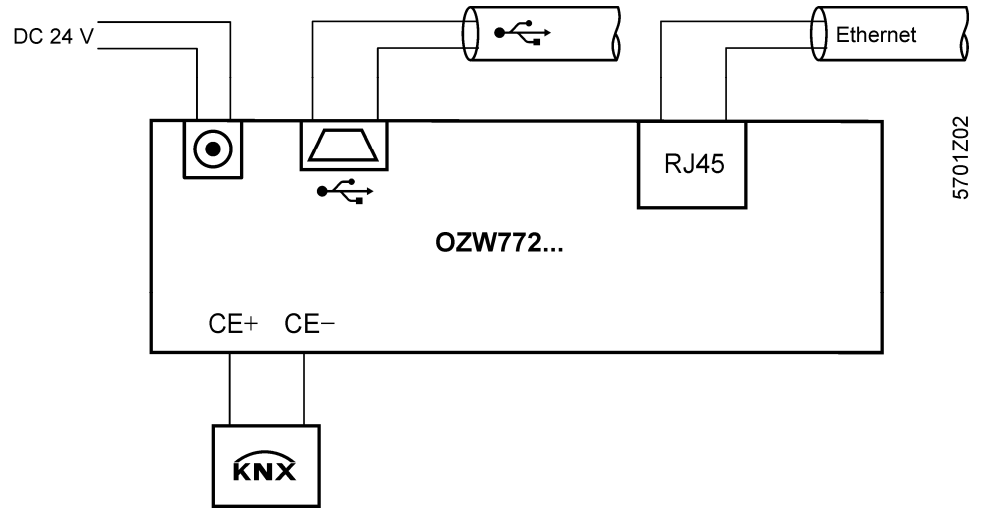

Connection terminals
KNX

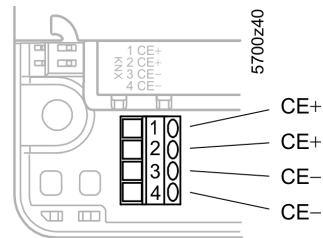

Pin assignment
DC 24 V plug

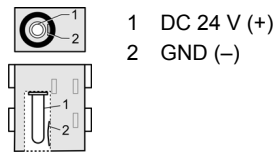

Dimensions

